

TROIS CYLINDRES AVEC CARBURATEUR IMPERATOR

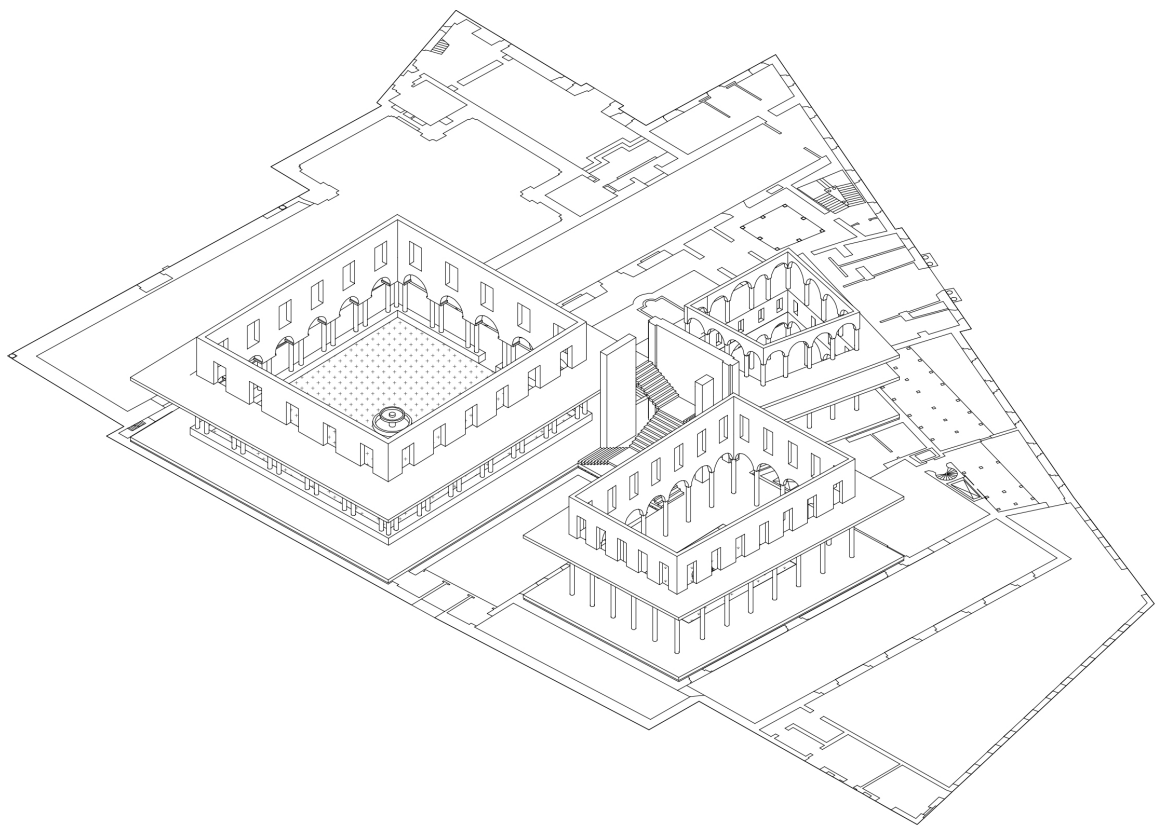

AVEC

L'Architecture ®

Design and Quality
Museo de las Bellas Artes of Sevilla

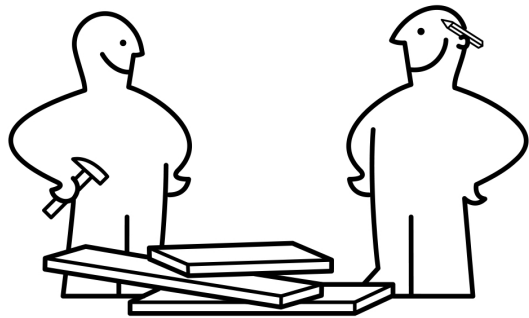
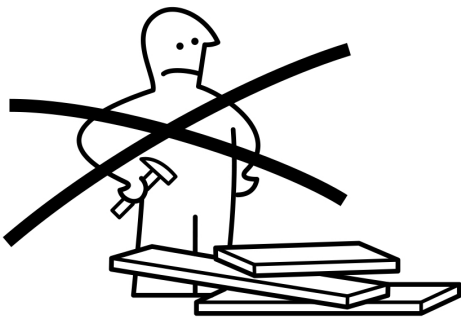
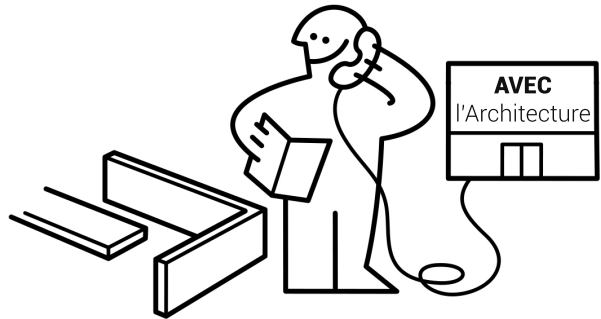
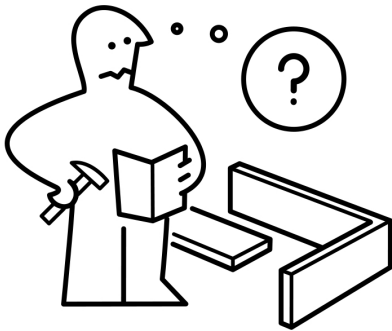
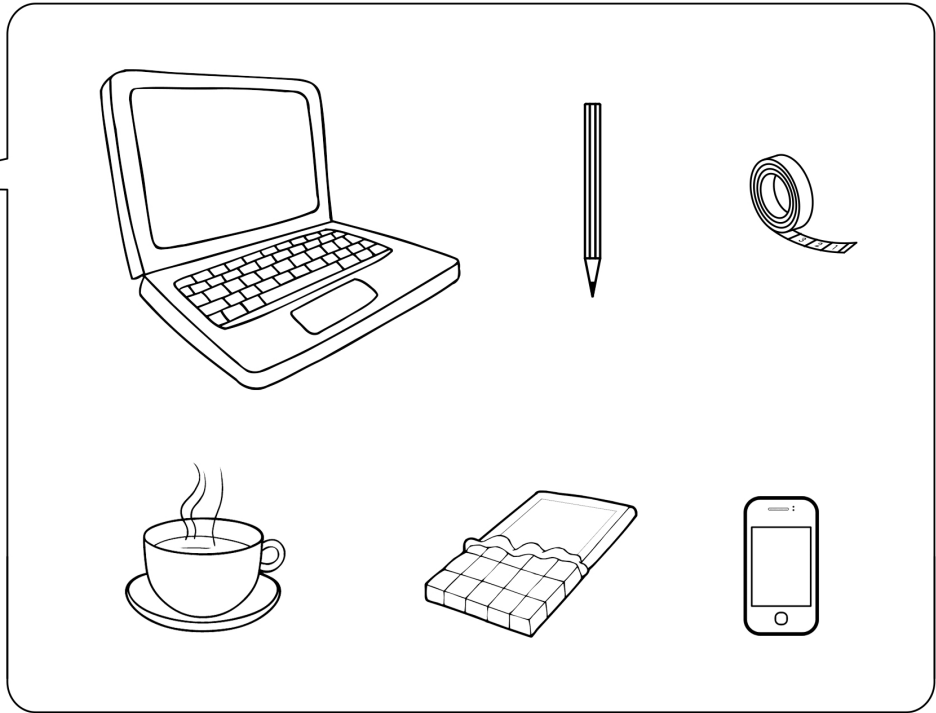

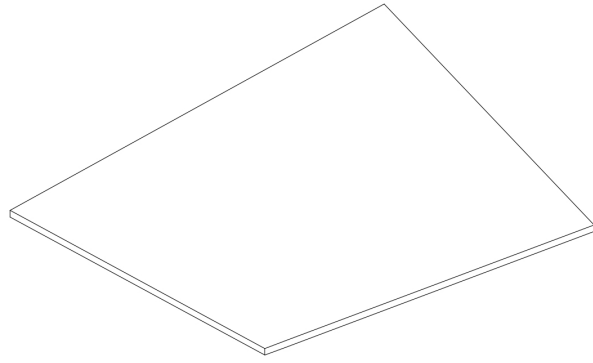

Socle Patio #1

X 1

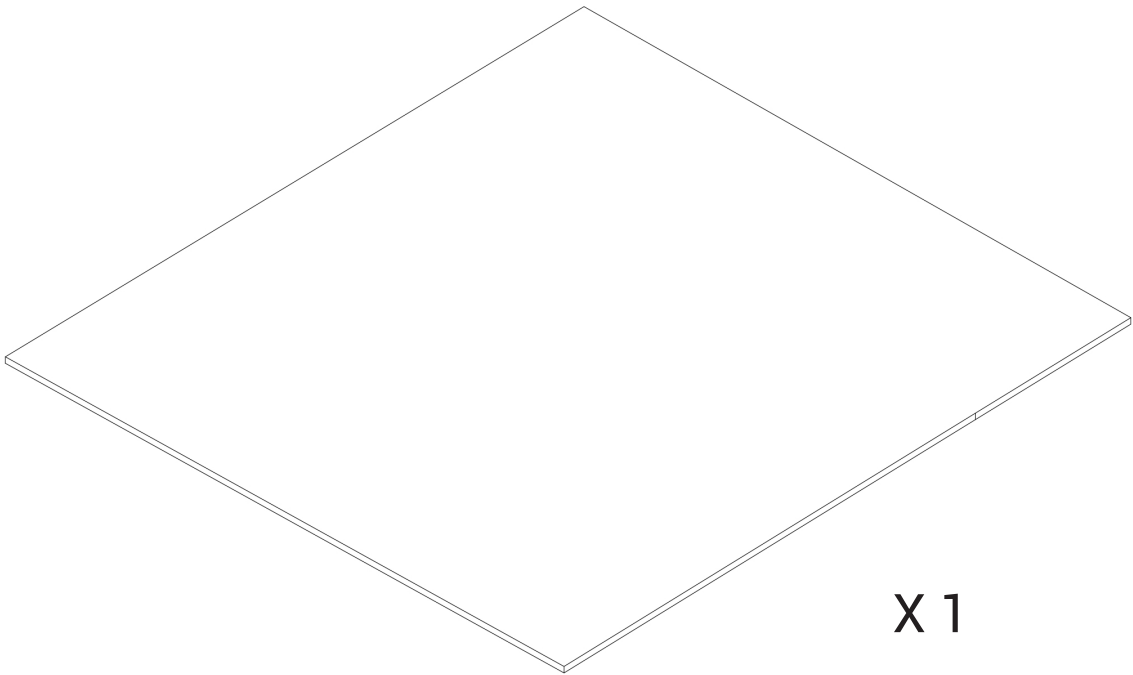

Socle Patio #3

X 1

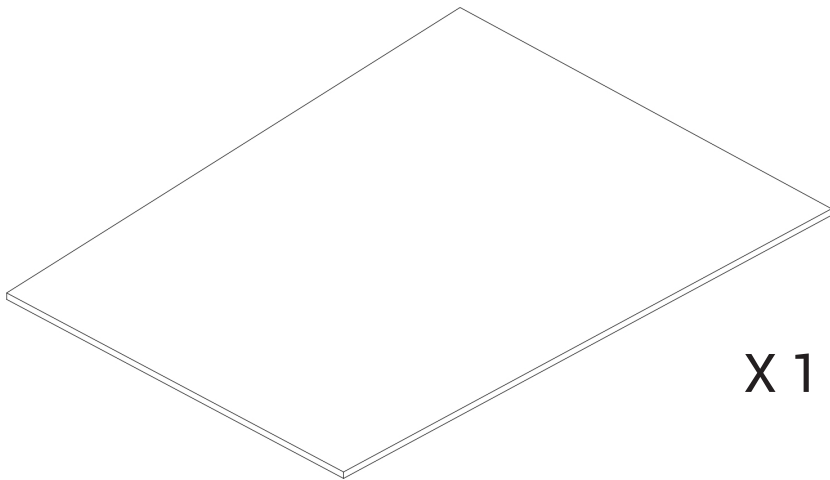

Socle Patio #2

X 1

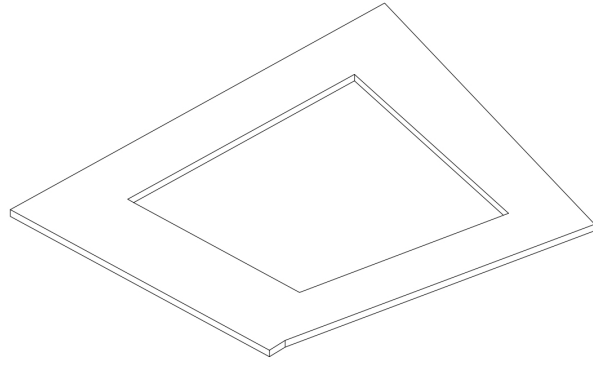

Circulation Patio #1

X 1

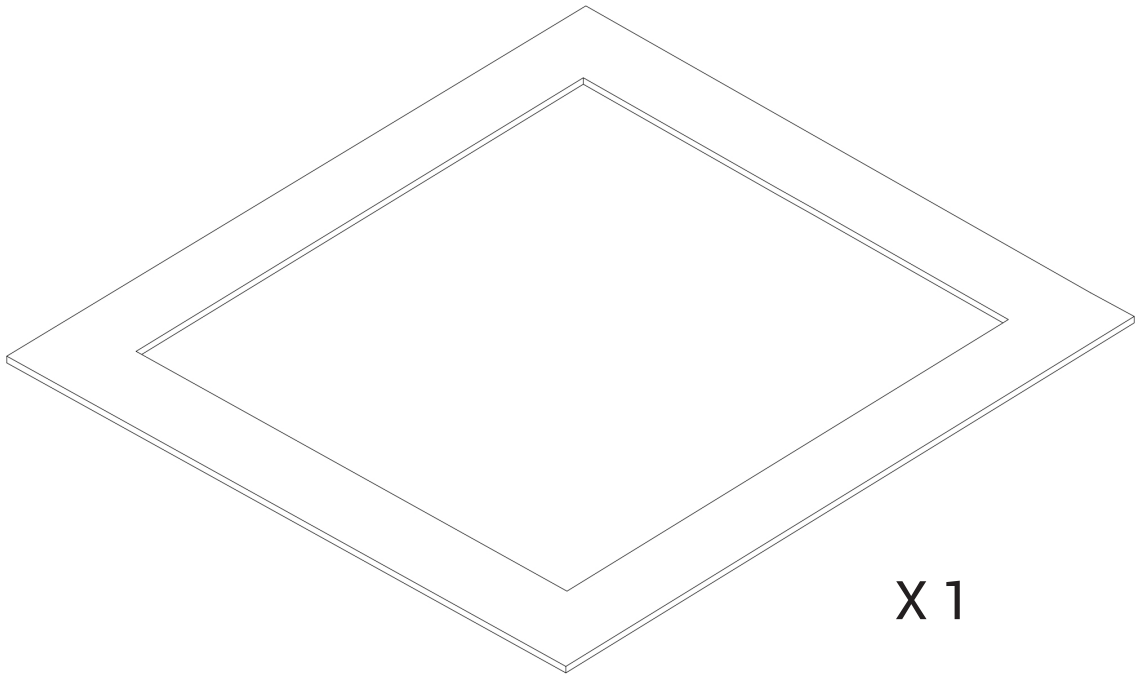

Circulation Patio #3

X 1

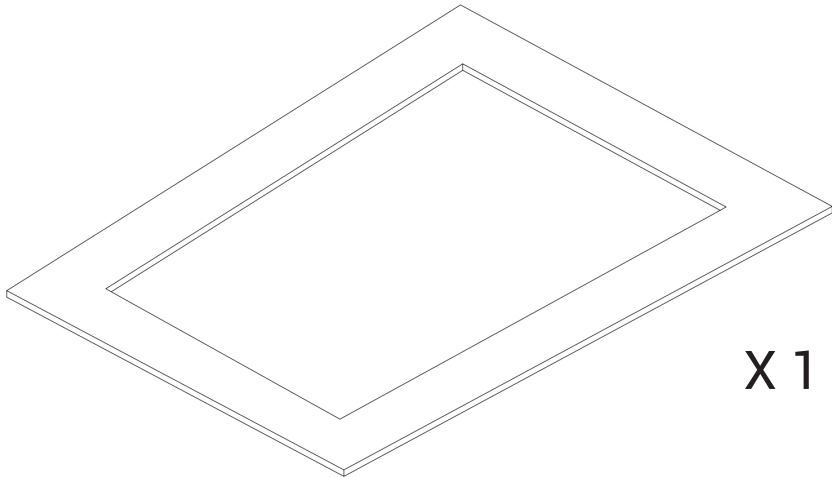

Circulation Patio #2

X 1



Style long et fin

X 24

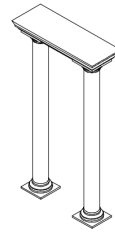

Style double

X 23



Style petit et gros

X 18

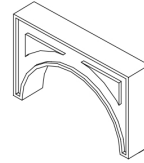

Arc #1

X 23

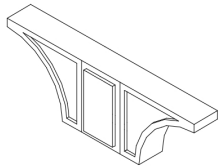

Deux-demi arc

X 23

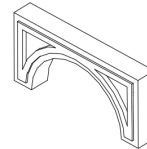

Arc #2

X 17

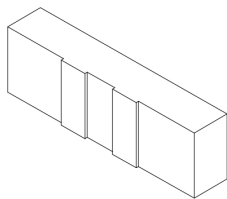

Muret-socle

X 85 ml



Puits

X 1

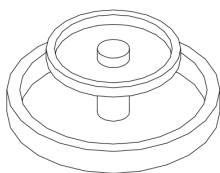

Grande Fontaine

X 1



Petite Fontaine

X 1

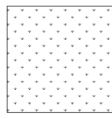

Jardin «À la Française»

X 110 m²

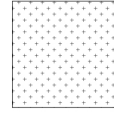

Jardin Exotique

X 441 m²

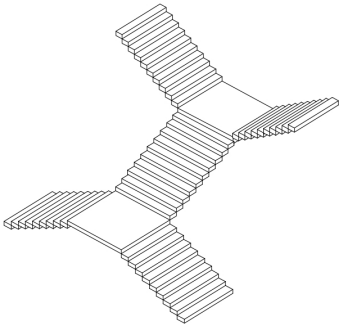

Escalier à deux doubles volées
Baptisé «Carburateur Imperator»

X 1

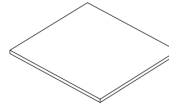
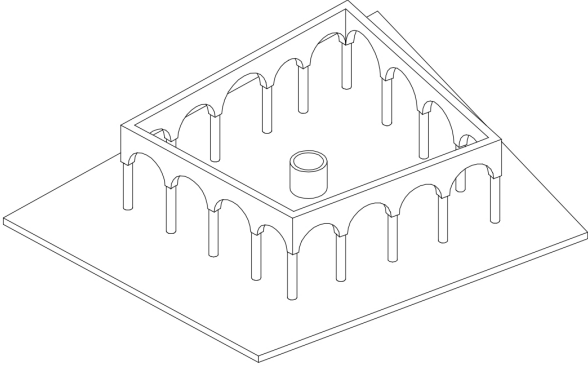

Plate-forme ou «Hub»

X 1

1



PATIO #1

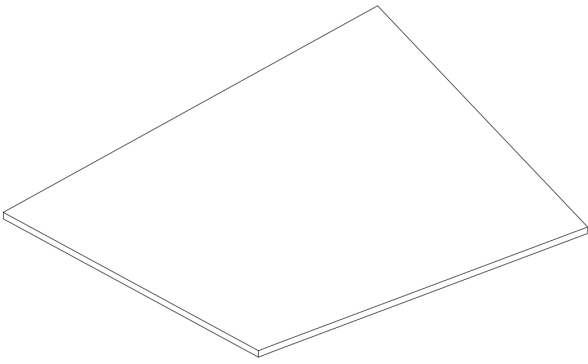

Scale Patio #1

X 1



Style petit et gros

X 18

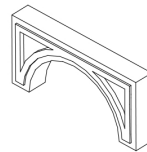

ATC #12

X 17

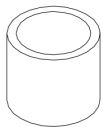

Puits

X 1

2

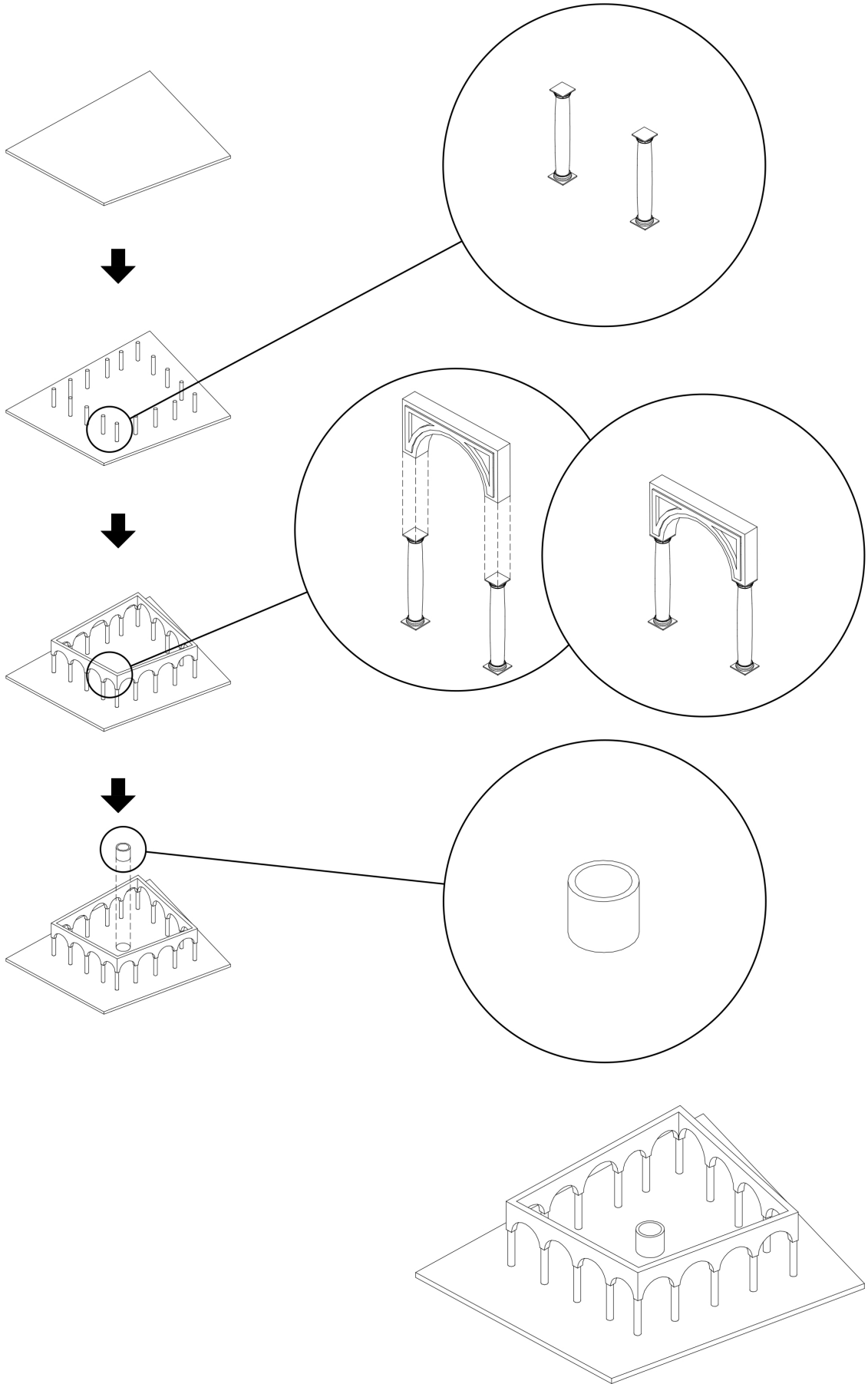

3

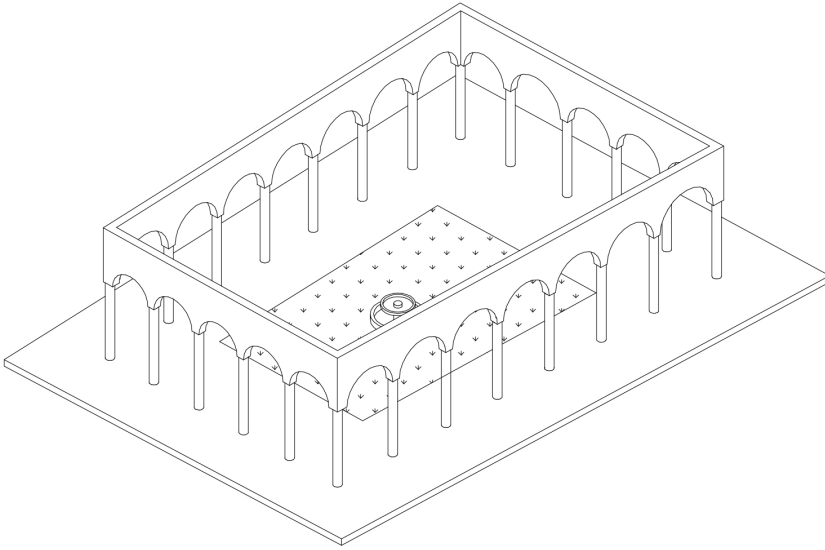

PATIO #2

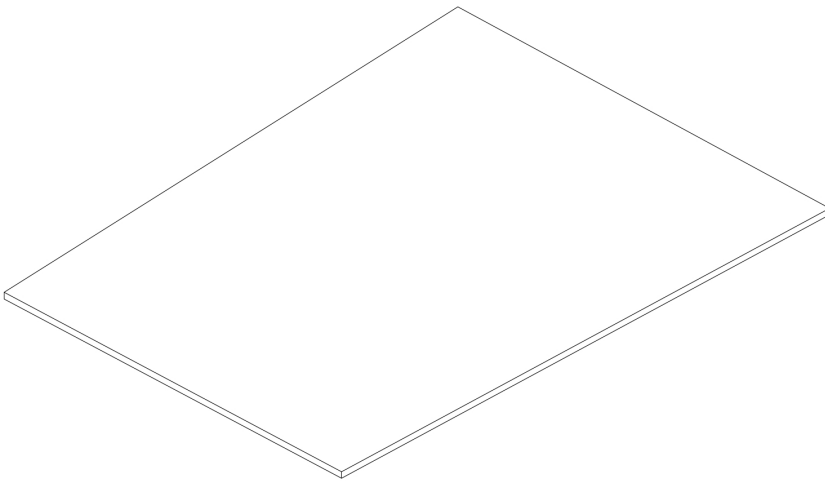

Socle Patio #2

X 1



Style long et fin

X 24

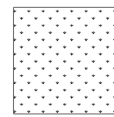

Jardin dit «à la française»

X 110 m²

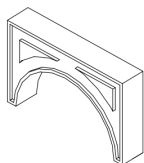

Arc #1

X 23

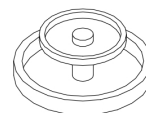

Petite Fontaine

X 1

4

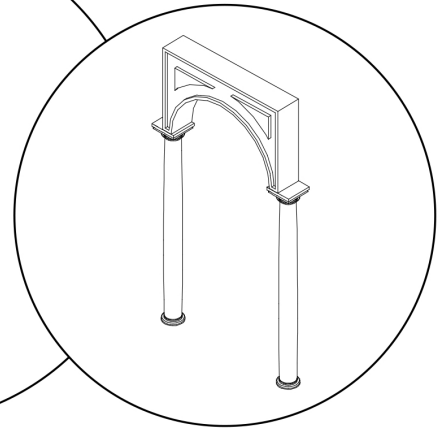
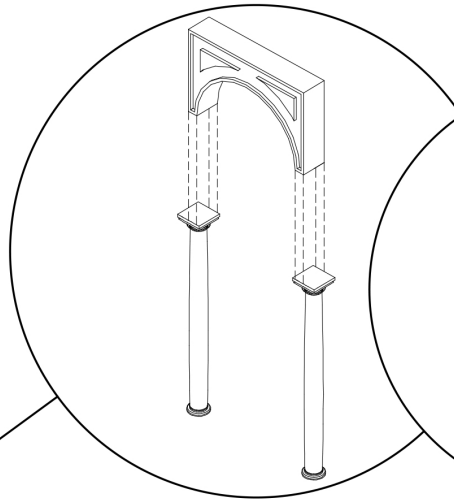
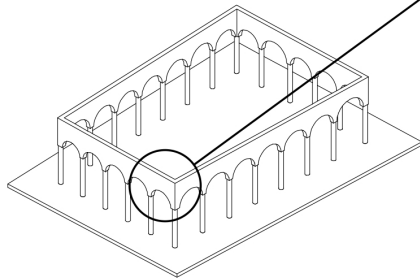
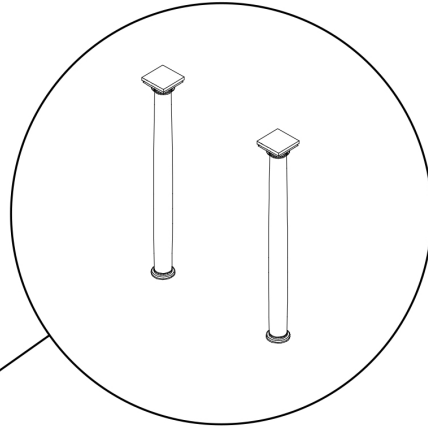
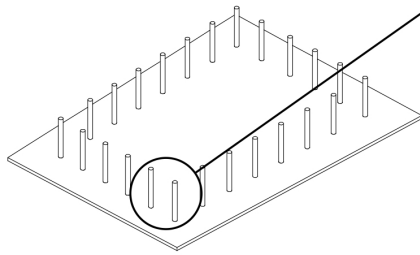
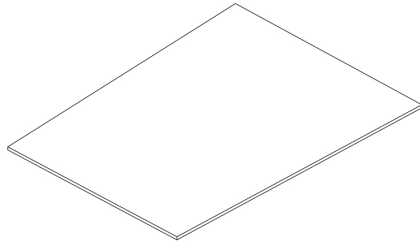

5

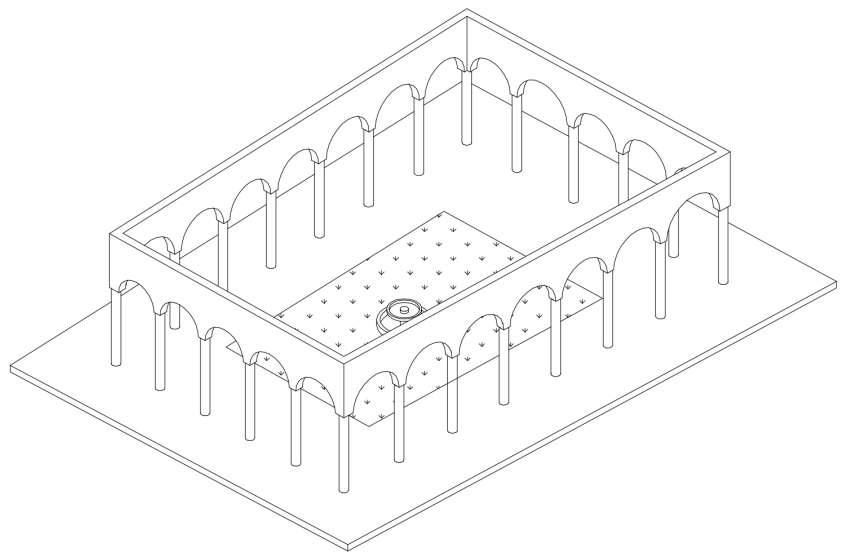
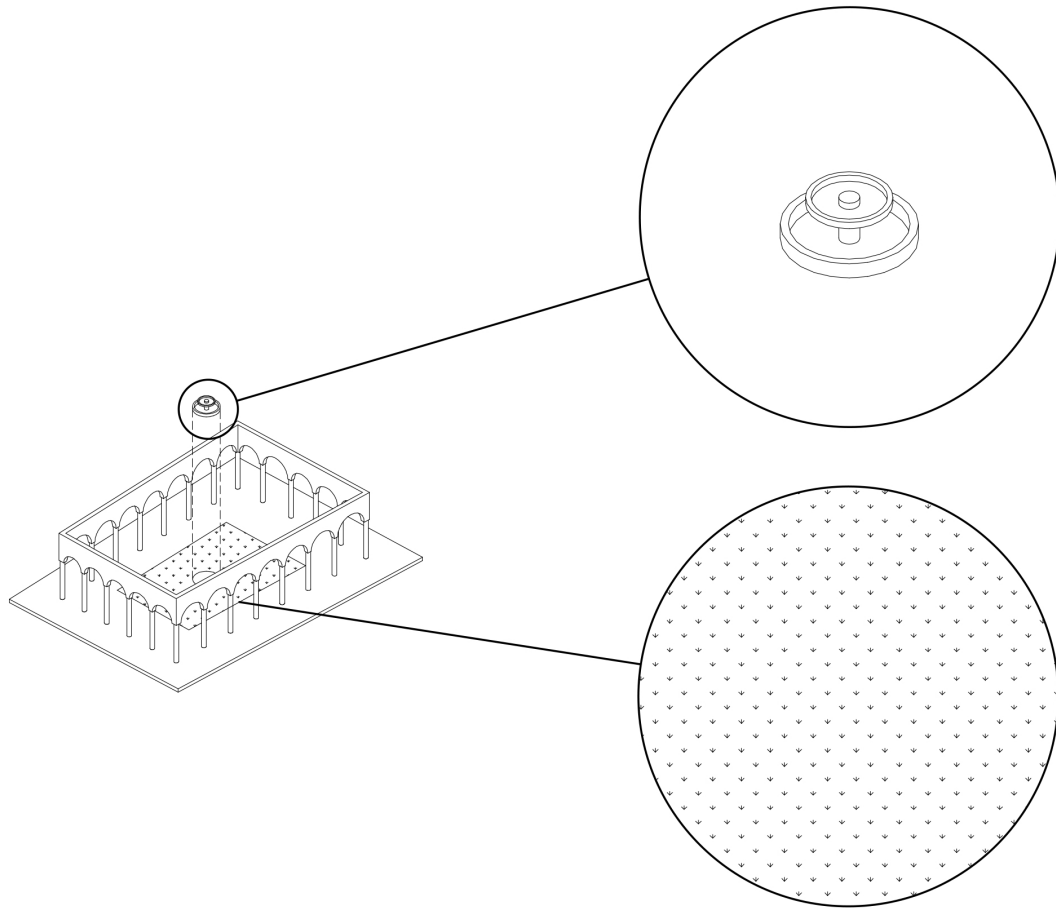

6

PATIO #3

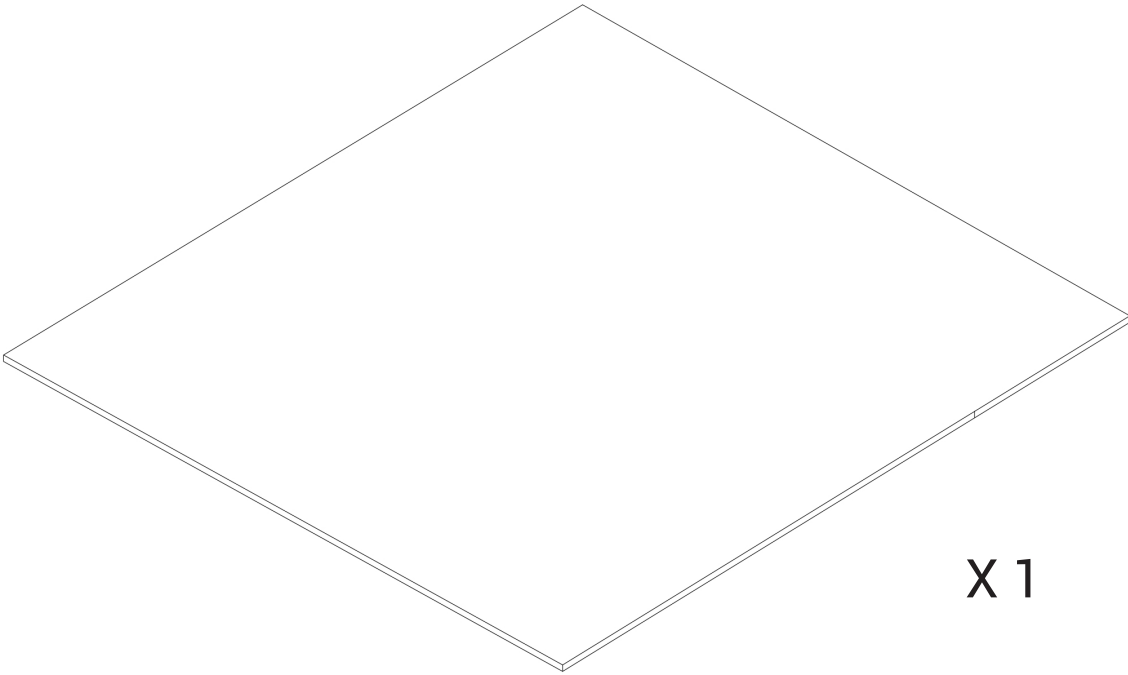
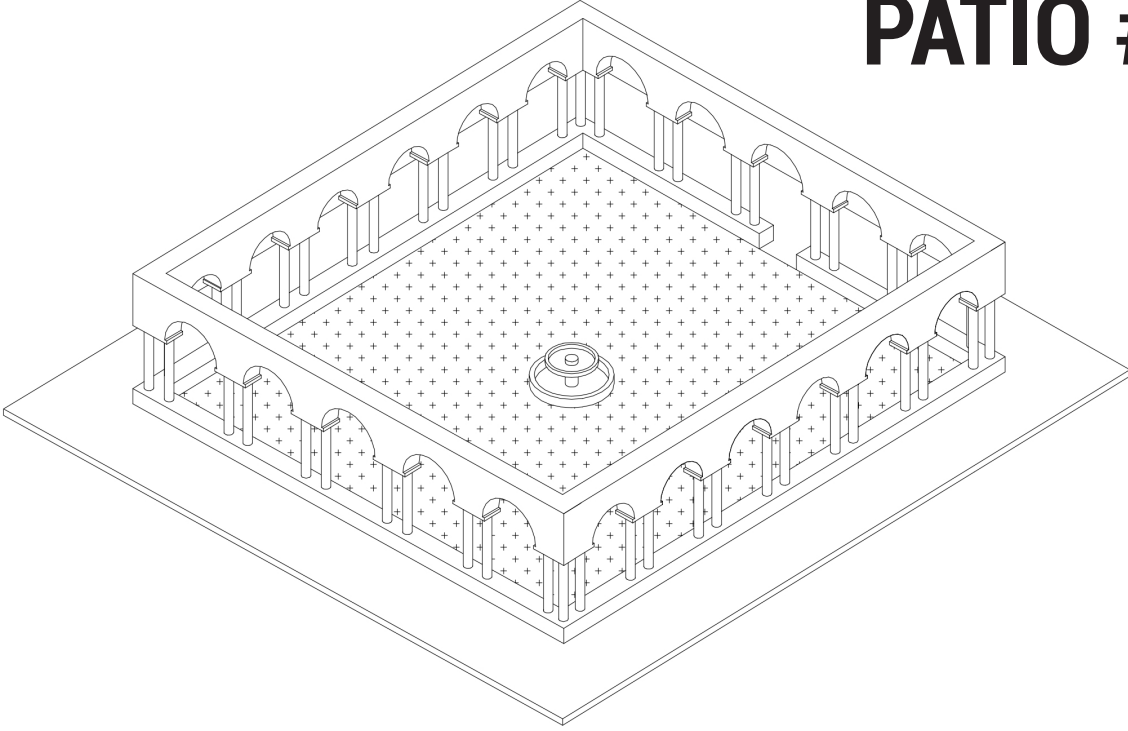

Socle Patio #3

X 1

7

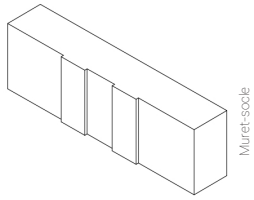

X 85 ml

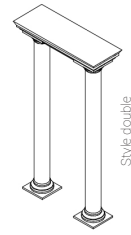

X 23

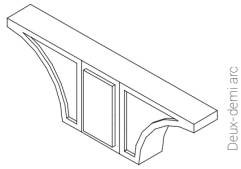

X 23

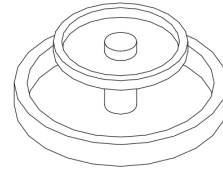

X 1

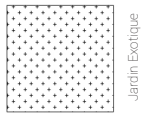

X 441 m²

8

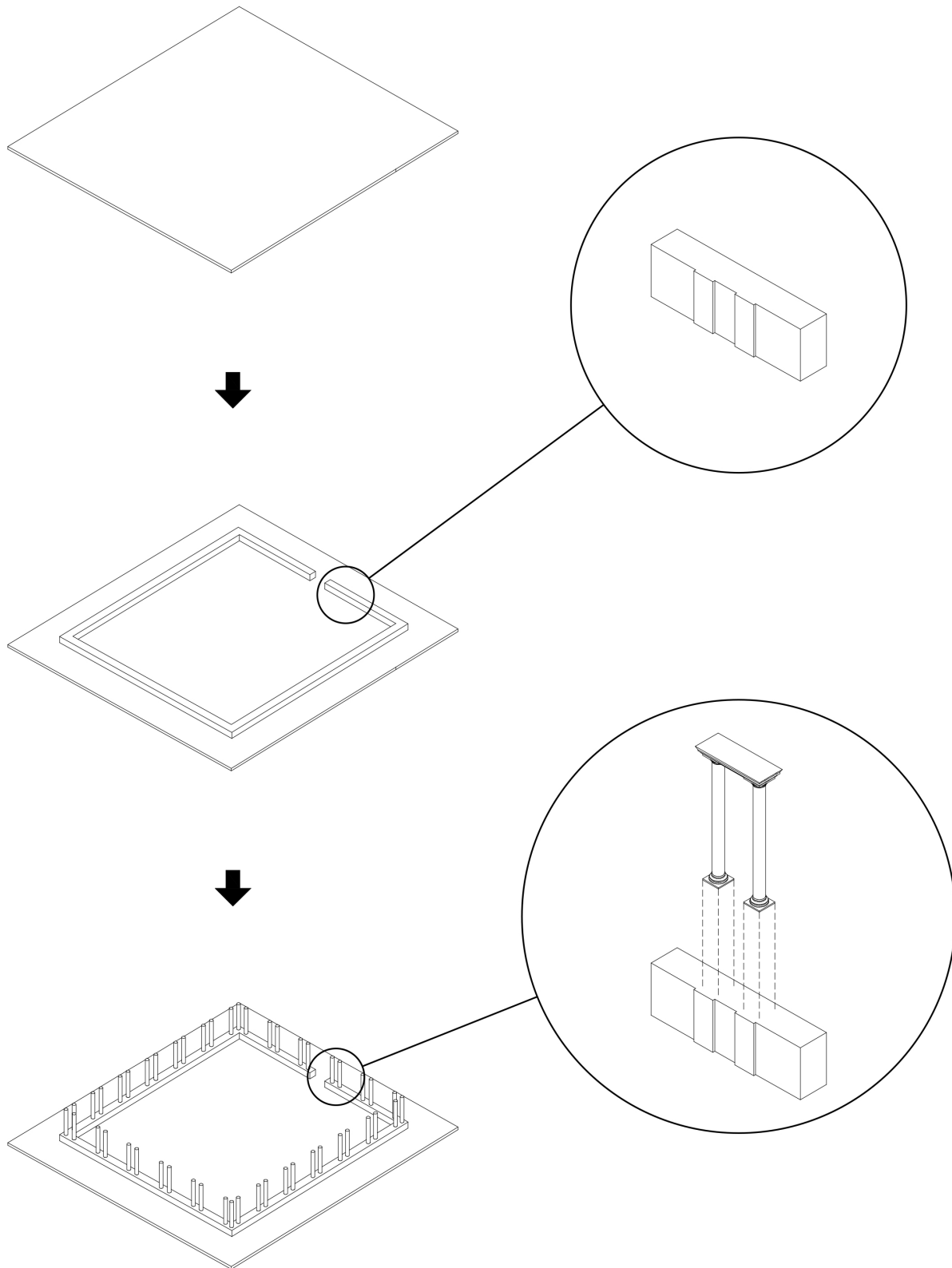

9

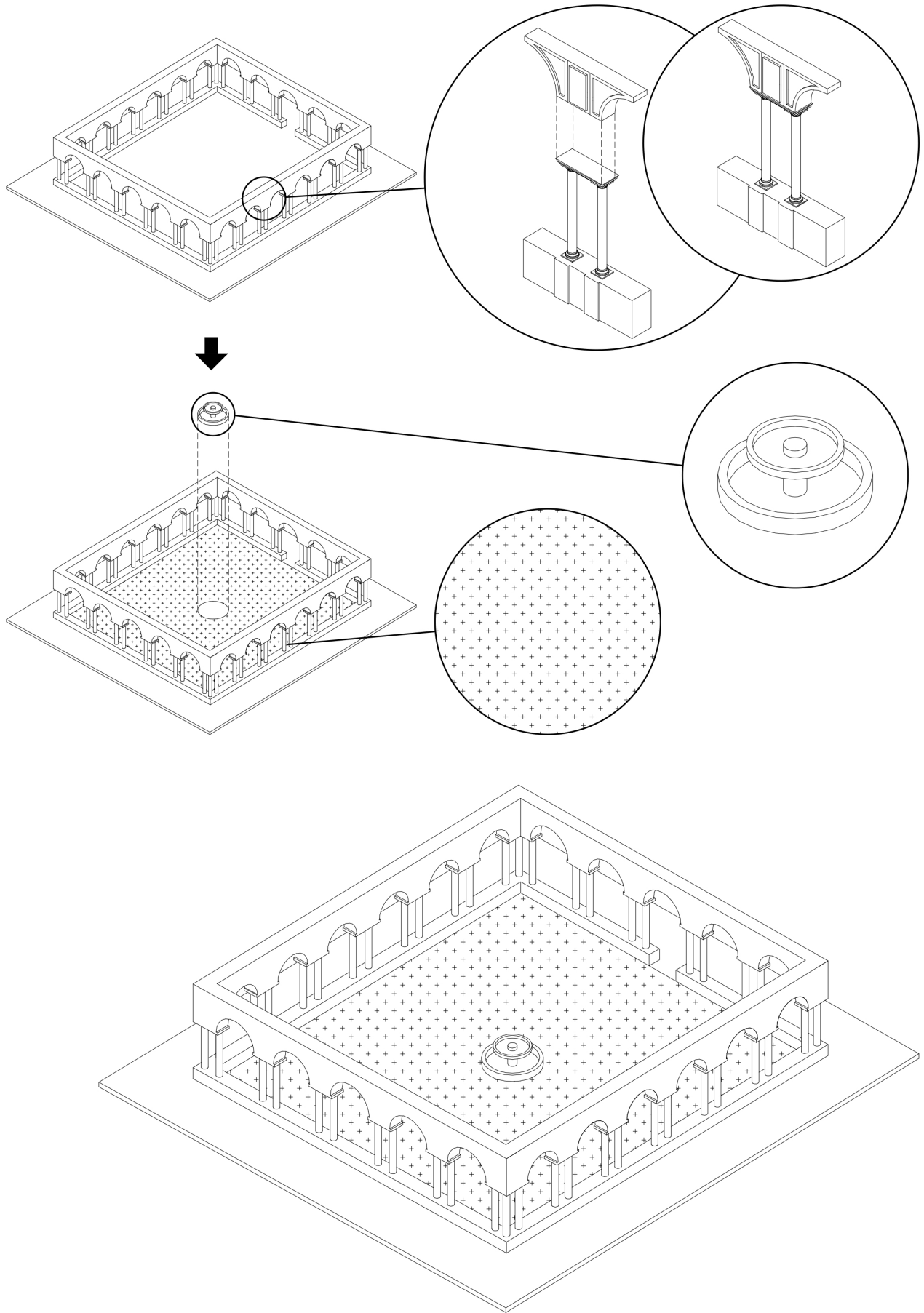

10

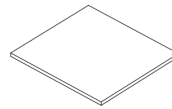
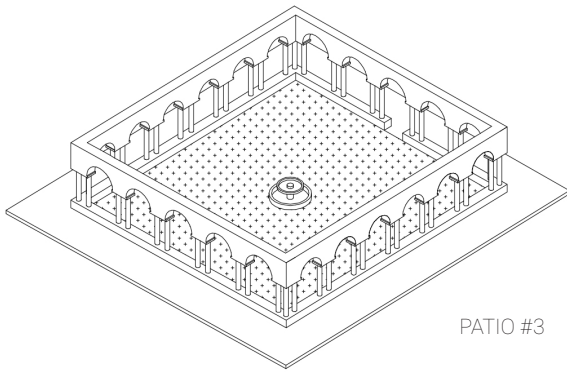
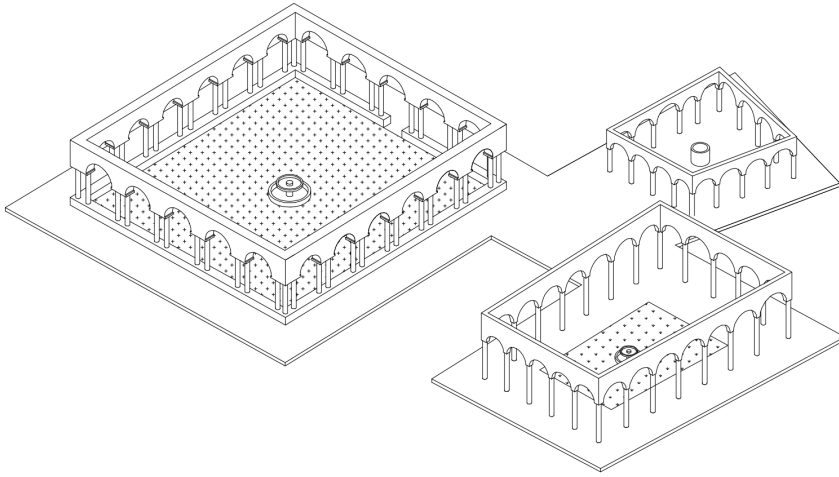
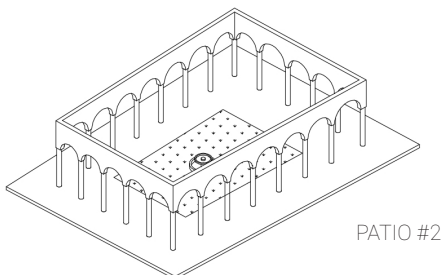
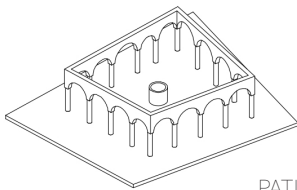
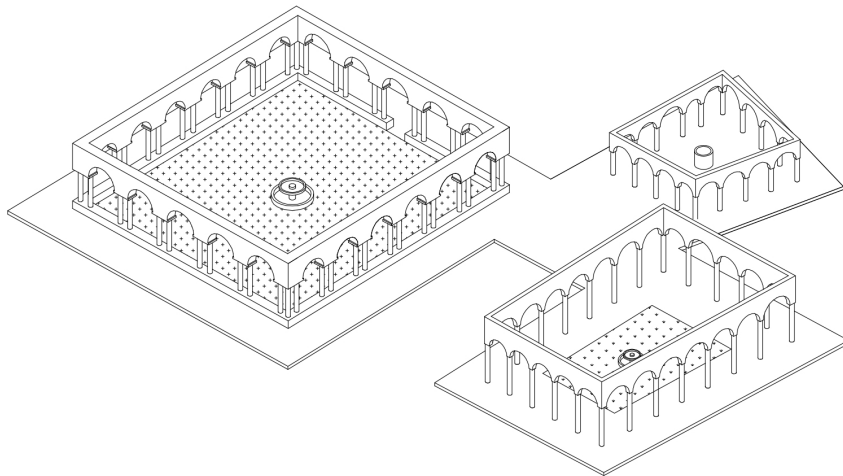
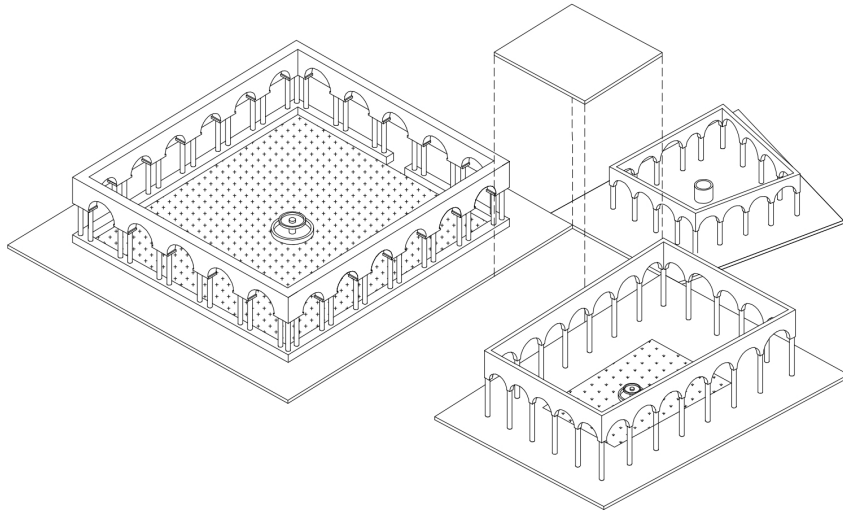
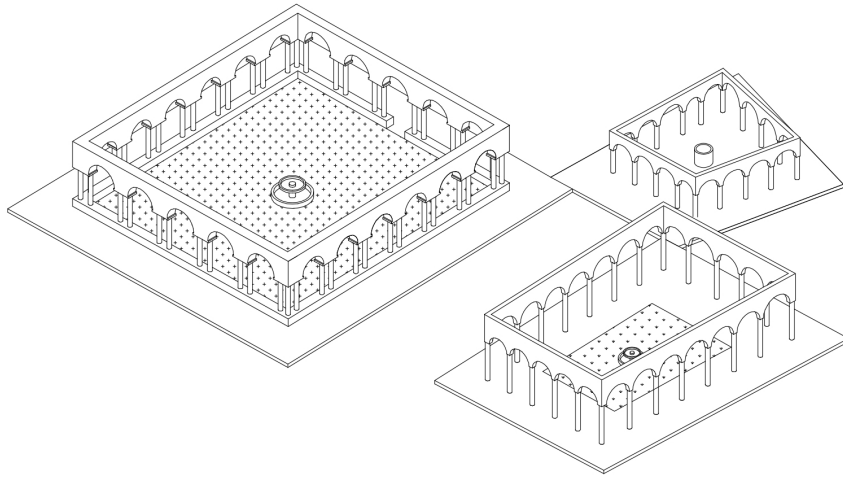

Plate-forme ou «Hub»

X 1



11



12

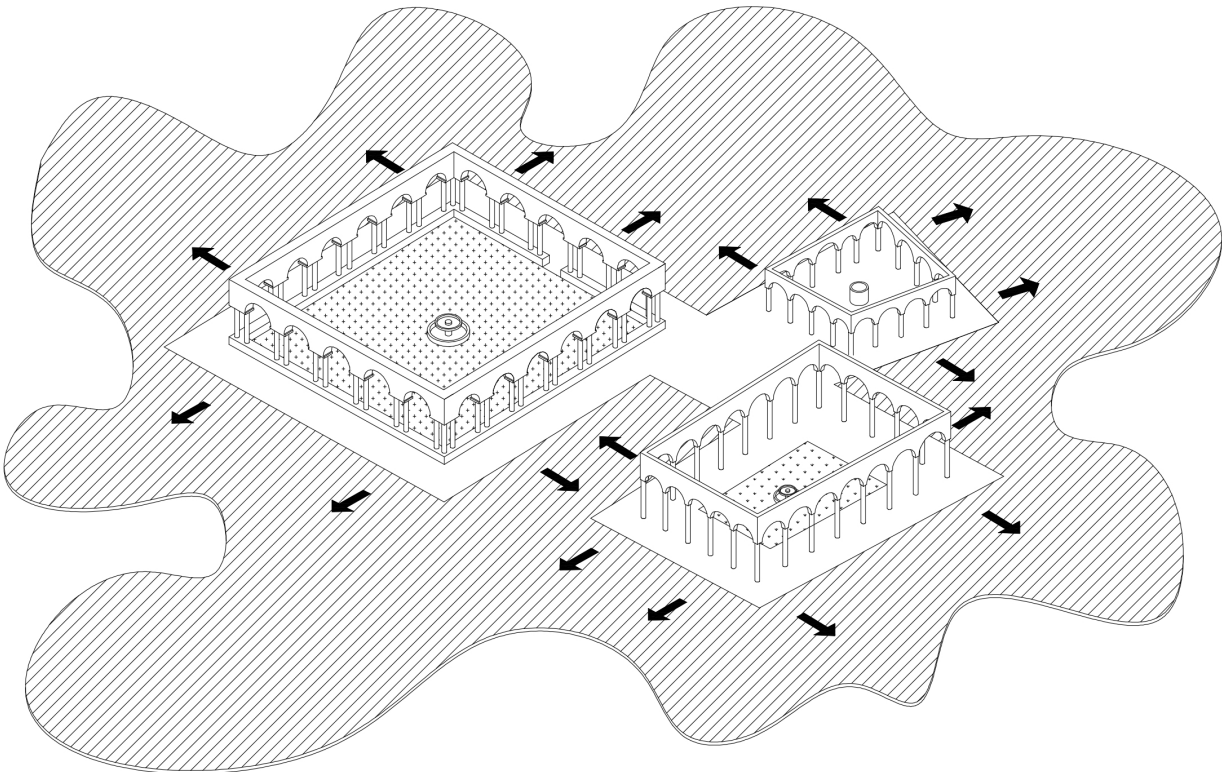
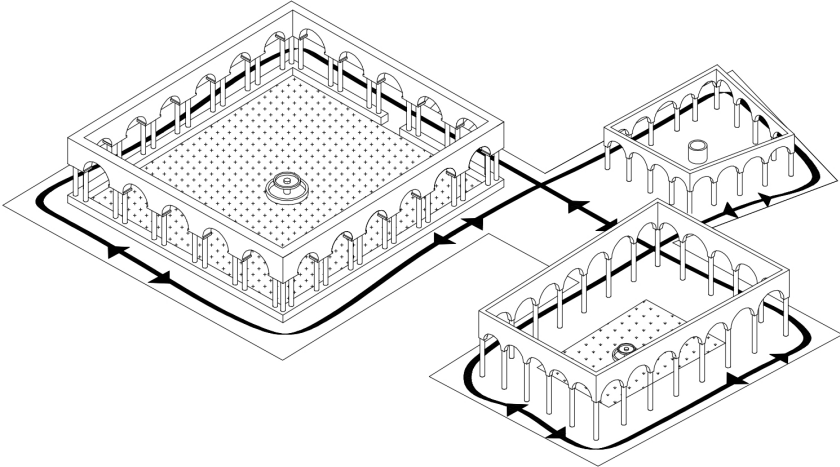

13

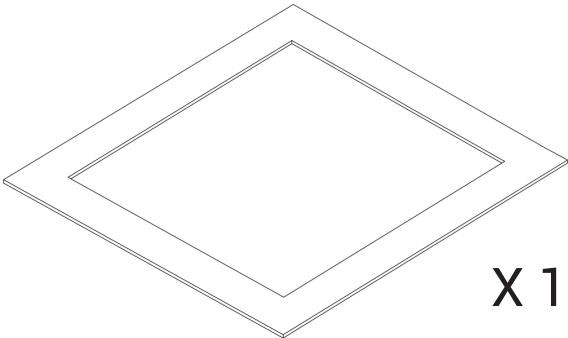
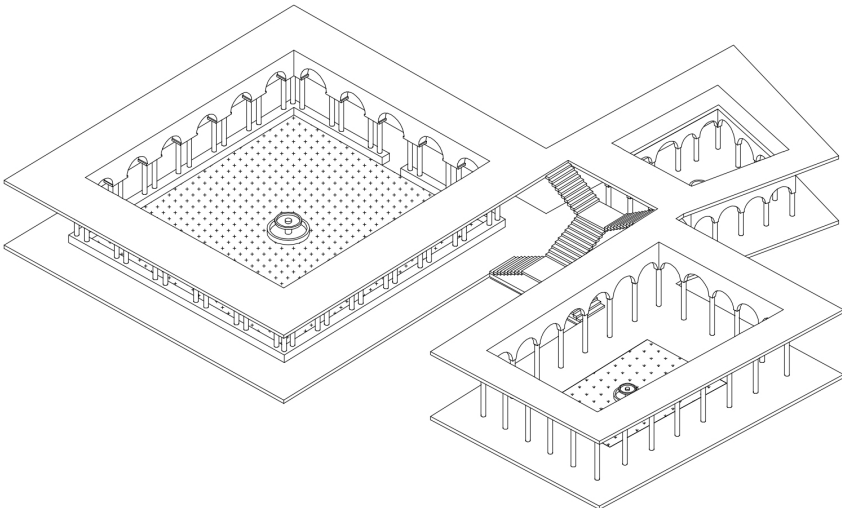

Circulation Patio #1

X 1

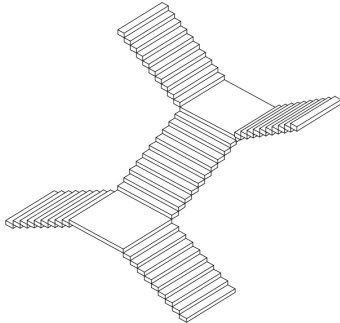

Escalier à deux doubles volées
Baptisé «Carburateur Imperator»

X 1

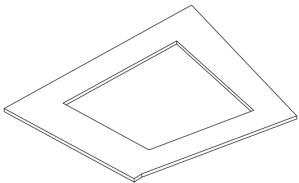

Circulation Patio #3

X 1

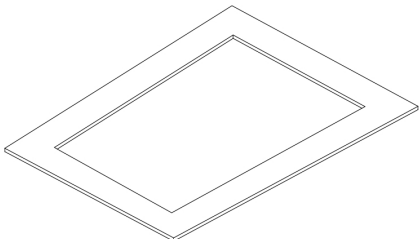

Circulation Patio #2

X 1

14

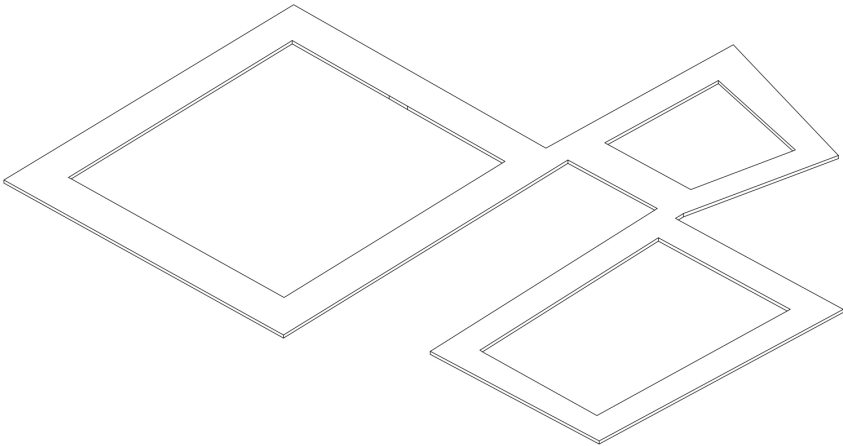
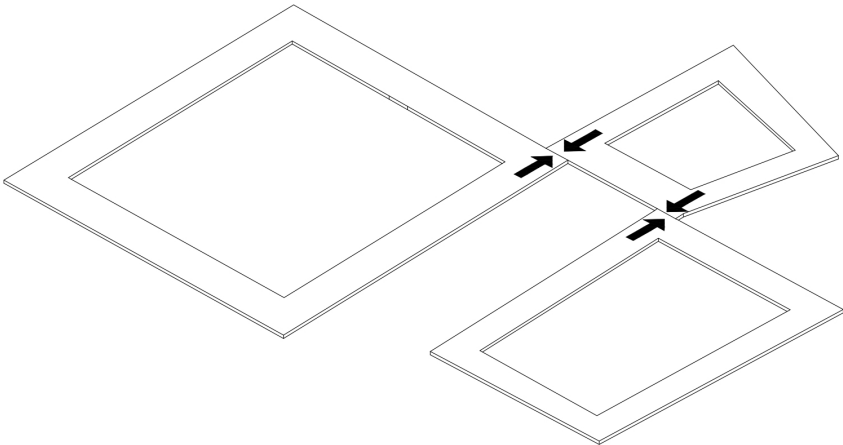
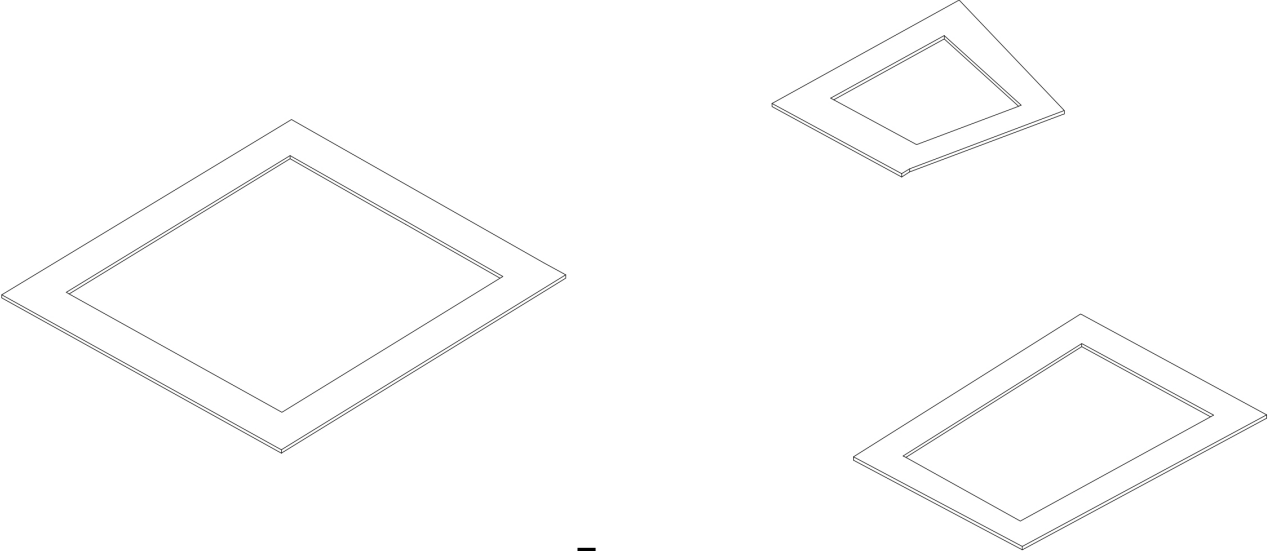

15

